

4. vector® award...



vector®

...für mutige Energiezuführungslösungen und e-kettensysteme® mit Leitungen.

...for inspiring energy supply solutions and e-chainsystems® with cables.

2014

4. vector®/Die Preise

4th vector®/The prizes

Weltweit brauchen Maschinen Energie

Moderne Kunststoff-Energieketten sind die Nabelschnur unter anderem des Maschinen- und Anlagenbaus und der Automation. Sie ermöglichen die sichere Zuführung von Energie, Daten, Impulsen und Medien und sind dabei ständig in Bewegung. Energieketten sind vom Kran- über den Werkzeugmaschinenbau, von der Robotik bis hin zu Reinräumen nahezu universell einsetzbar. Der vector® award zeichnet mutige Anwendungen in der Energiezuführung aus.

Der Wettbewerb ist eine weltweite Gemeinschaftsinitiative der igus® GmbH zusammen mit MM MaschinenMarkt. Als Techniker und Wissenschaftler sind außerdem Vertreter des Zentralverbands Elektrotechnik- und Elektronikindustrie e.V. und des Werkzeugmaschinenlabors der RWTH Aachen in der Jury. Der vector® award steht unter der Schirmherrschaft von Ken Fouhy, Chefredakteur der VDI nachrichten.

Machines need energy all over the world

Modern polymer energy chains® are the umbilical cord of the automation, machine and plant engineering industries. These energy chains® ensure the safe supply of energy, data, pulses and operating media and are always in motion. energy chains® are suitable for multipurpose use in the crane and machine tool industries and in the robotics and clean room industries. The vector® award honours bold energy supply applications.

The contest is a joint, worldwide initiative between igus® GmbH and MM MaschinenMarkt. The jury also includes engineers and scientists representing the German Central Association of Electrical Engineering and the Electronics Industry and the RWTH Aachen University. The vector® award is under the patronage of Ken Fouhy, Chief Editor of VDI nachrichten.

5.000 €
2.500 €
1.000 €

der vector® award umfasst

die goldene vector®-Statue, Urkunde und ein Preisgeld von 5.000 €
die silberne vector®-Statue, Urkunde und ein Preisgeld von 2.500 €
die bronzene vector®-Statue, Urkunde und ein Preisgeld von 1.000 €

the vector® award comprises

the gold vector® trophy, a certificate and € 5,000 in prize money
the silver vector® trophy, a certificate and € 2,500 in prize money
the bronze vector® trophy a certificate and € 1,000 in prize money

Die Jury

The Jury



Schirmherr/patron



VDI nachrichten

Ken Fouhy
Chief Editor,
VDI nachrichten

jury



Dipl.-Ing. Frank Jablonski
Chief Editor
MM MaschinenMarkt



Tessa Forsblad
Hannover Messe



Prof. Dr.-Ing. Christian Brecher
Head of the Machine Tool
Laboratory Chair
RWTH Aachen



Ralf-Martin Müller
General Manager Energy
TÜV Rheinland LGA
Products GmbH



Thomas Rilke
CEO Robotation Academy



Harald Nehring
Vice President
e-chainsystems®
igus® GmbH

Weitere Einsendungen

Further applications



**Dr Zaber Ltd., Marek Brzezinski,
Nowy Sacz, Poland**
Schleifmaschine
Sanding machine

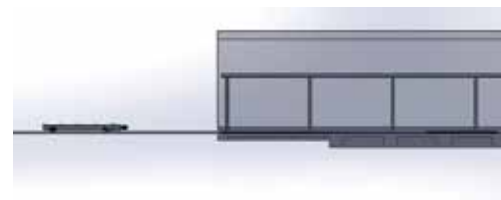

**Pacific States Cast Iron Pipe Company,
Brent Noel, Provo, USA**
Transportwagen
Transport cart



**Monstal S.C, Marek Brela, Wałbrzych,
Poland**
Maschine
Machine

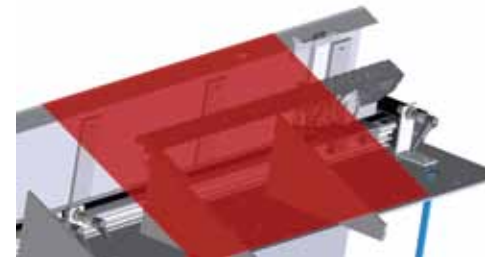

Smyth, Matteo Cerruti, Moncalvo, Italy
Buchbindemaschine
Bookbinding machine

Weitere Einsendungen

Further applications



**Umbelino Monteiro SA, Rui Jorge Lopes
Marques, Pombal, Portugal**

Trockner für Dachziegel
Dryer for roof tiles



**CIMPOR, Paulo Jorge Oliveira Pereira,
Coimbra, Portugal**

Verpackungsmaschine
Packaging machine



**Cimolai Technology spa,
Donato Cecchin, Carmignano di Brenta,
Italy**

Spezialfahrzeug
Special vehicle

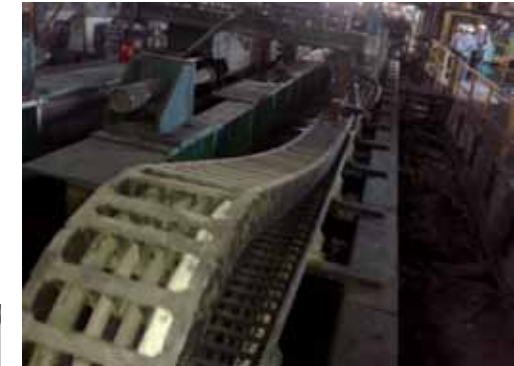

**Jindal Saw Limited A59/60
Midc Sinner Nashik, Manoj Mishra,
Nashik Road, India**

Walzwerk
Roller mill

Weitere Einsendungen



**Z.P.U.H. Mikron S.C. Marcin
Sobun, Waclaw Kurowski,
Krzysztof Sobun, Wiamowice,
Poland**
Manipulator
Manipulator

**Handsaeme Machinery,
Matthias Vermeulen, Izegem, Belgium**
Laminator
Laminator



Further applications

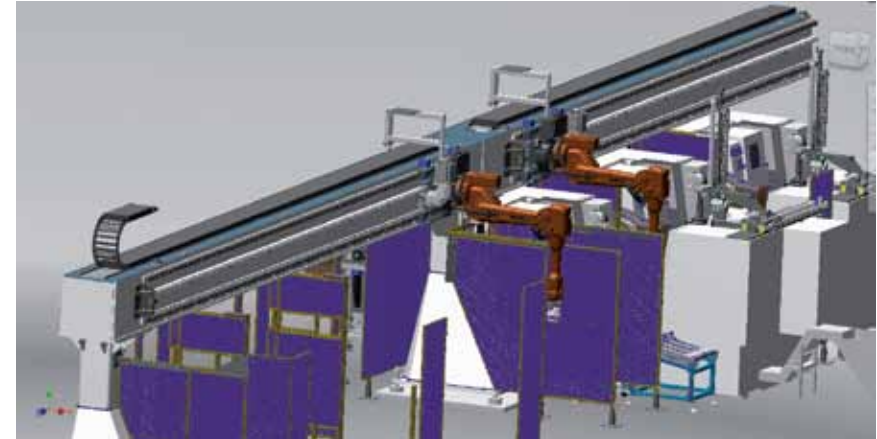

Pt. Astra Otoparts Winteq Division, Deby Primadani, Bogor, Indonesia
Industrieroboter
Industrial robot

**MCRS Technology s.c.,
Jacek Stasiewicz, Starolecka,
Poland**
Produktionsmaschine
Production machine



Weitere Einsendungen



**Ken Ichi Machine Co. Ltd.,
Brandon Wu, Taichung, Taiwan**

Produktionsmaschine
Production machine

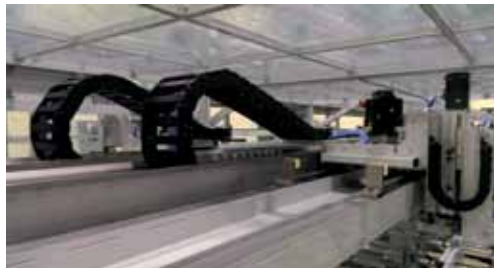

**Shuz Tung Machinery Industrial Co.,
Ltd., Su-How Yang, Taichung City,
Taiwan**

Produktionsmaschine
Production machine

Further applications

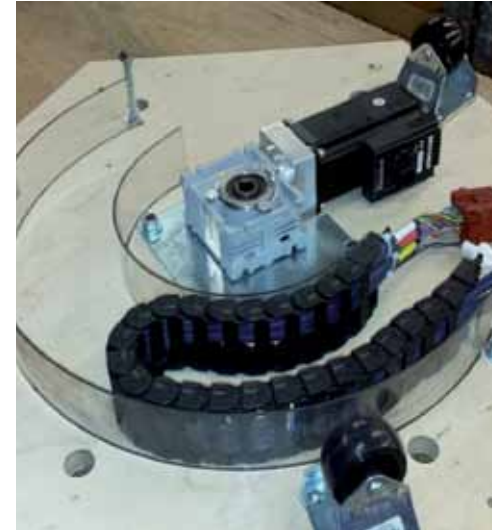

VdW International, Stéphane De Cousse-maker, Ganshoren, Belgium
Spielautomat
Gaming machine



**Gepro Systems SL, Patxi Etxebarria,
Durango, Spain**
Produktionsmaschine
Production machine

Weitere Einsendungen

Further applications



**DUX Budowa Maszyn Dorota Denysiuk,
Marian Walkusz, Gdynia, Poland**

Teststation
Test station



**BARDINET, François Viste, Blanquefort,
France**

Abfüllanlage
Bottling plant



Global Machine Innovations, Robert Freese, Bridgend, UK

Schneidemaschine
Cutting machine

Weitere Einsendungen

Further applications



**Continental Automotive do Brasil,
Carlos Bifani, Várzea Paulista, Brazil**

Transportmaschine
Transport machine

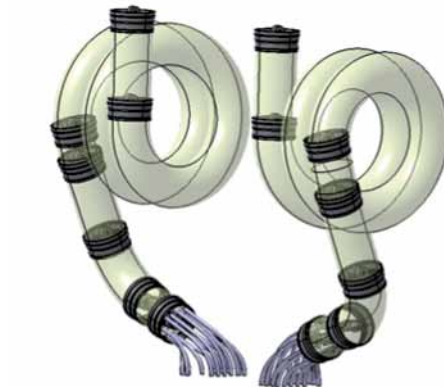

**Sogeclair Aerospace S.A.,
Sebastien Pintos, Getafe, Spain**

Luftfahrtgerät
Aviation device

Further applications



**TTM Tomasz Tobiasz, Tomasz Tobiasz,
Bratucice, Poland**

Montagelinie
Assembly line

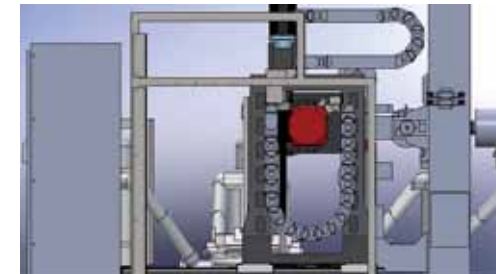

**Manford Machinery Industrial Co. Ltd.,
Stanley Huang, Nantou County, Taiwan**

Produktionsmaschine
Production machine

Weitere Einsendungen

Further applications



**Daeduk ENG, Samryong Seo,
Gimcheon-si, Gyungsoangbuk-do, Korea**
Transportsystem
Transport system



**Fiat Auto Poland, Andrzej Bednorz,
Tychy, Poland**
Transportsystem
Transport system



**Koike Korea, Junghoon Kim,
Gimcheon-si, Gyungsoangbuk-do,
Korea**
Plasma-Schneidemaschine
Plasma cutting machine



Weitere Einsendungen



STEEL FLOWER,
Jakyung Ku, Pohang-si,
Kyungsangbuk-do,
Korea
Produktionsmaschine
Production machine



Van Hoecke Automation nv, Steven Van Cauwenberghe,
Gavere, Belgium
Industrieroboter
Industrial robot

Further applications



Vinyl I, Intak Joo, Seoul, Korea
Kunstinstallation
Art installation

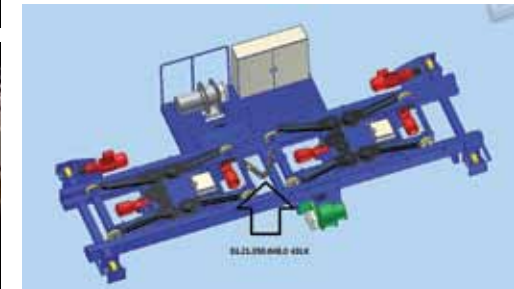

Dongyang Menics Co. Ltd., Joo-Sung Kim, Seoul, Korea
Automatisches Parksystem
Automatic parking system

Weitere Einsendungen

Further applications



Eternal Vigor Technology, Chu Joseph,
New Taipei City, Taiwan
Produktionsmaschine
Production machine

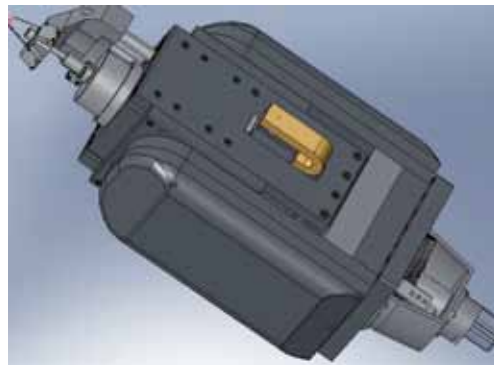

Yixing Xinyu Technology Co., Ltd.,
Shusheng Zhang, Yixing, China
Industriemaschine
Industrial machine



AP&T AB, Göran Fischer,
Blidsberg, Sweden
Produktionsmaschine
Production machine



Weitere Einsendungen

Further applications



**China Steel Corporation, Yenhung Lin,
Kaohsiung City, Taiwan**

Kran
Crane



**Geng-Shuen Co. Ltd., Jason Shen,
Taichung City, Taiwan**
Produktionsmaschine
Production machine



**Hardinge Taiwan Precision Machinery,
Kin Chen, Nantou County, Taiwan**
Produktionsmaschine
Production machine

Teilnehmer

ABB Ltda., Julio César Antonio Real, Votorantim, Brazil	121
ABB S.A., Jorge Velázquez, Madrid, Spain	79
Acela Design / Ergonomic Products, Richard Genga, East Greenwich, USA	28
Agramko, Martin Petersen, Sønderborg, Denmark	
AlpinaTec Technical Products GmbH, Roman Froschauer, Köstendorf, Austria	100
ALTIM, Krzysztof Karlewski, Ciechanów, Poland	92
Aluminium Oxid Stade GmbH, Fabian Wilhelm, Stade-Bützfleth, Germany	40
Alzmetall, Robert Kleinschwärzer, Altenmarkt, Germany	99
António Cunha Leite Lda., Raúl Oliveira, Braga, Portugal	55
AP&T AB, Göran Fischer, Blidsberg, Sweden	143
ArcelorMittal Warszawa, Rafał Obszanski, Warszawa, Poland	36
Aritex Cading S.A., Marc Vilar, Badalona, Spain	114
Arlona Engineering, Dirk Venter, Durban, South Africa	88
Astra-Tec, Pieter Goethals, Lichtervelde, Belgium	96
Automatyzacja Procesów Przemysłowych, Michał Wajman, Zabrze, Poland	87
BARDINET, François Viste, Blanquefort, France	134
BD Bioscience, Scott Horton, San Jose, USA	51
BEC GmbH, Matthias Buck, Reutlingen, Germany	61
BRETINOV, Pierre Auffret, Tregunc, France	
Cameron Forecourt Ltd., Dennis West, Barnsley, UK	67
China Steel Corporation, Yenhung Lin, Kaohsiung City, Taiwan	144
Cimolai Technology spa, Donato Cecchin, Carmignano di Brenta, Italy	129
CIMPOR, Paulo Jorge Oliveira Pereira, Coimbra, Portugal	128
Clive Stewart, Stockport, UK	98
Continental Automotive do Brasil, Carlos Bifani, Várzea Paulista, Brazil	136

Participants



conZeta electronics, Pedro Chico Mellado, Elche, Spain	123
CS Glaziers North Wales Ltd., Neil Clarkson, Buckley, UK	
Daeduk ENG, Samryong Seo, Gimcheon-si, Gyung-sangbuk-do, Korea	138
Dearborn Mid-West Company, Mario Stegic, Lenexa, USA	
Delton pneumatics, D.pramod Surana, Chennai, India	
Deutsches Forschungszentrum für künstliche Intelligenz GmbH, Marc Simnofske, Bremen, Germany	111
DINOPOL Sp. z. o.o., Maciej Zmuda, Ostrow Wilk., Poland	37
Dodavky automatizace, spol. s r.o., Jiri Michnac, Ostrava, Czech Republic	73
Dongyang Menics Co. Ltd., Joo-Sung Kim, Seoul, Korea	141
Dr Zaber Ltd., Marek Brzezinski, Nowy Sacz, Poland	126
DUX Budowa Maszyn Dorota Denysiuk, Marian Walkusz, Gdynia, Poland	134
E. S. Boulos Company, Robert Goulet, Westbrook, USA	26
EC Engineering, Mateusz Wozny, Kraków, Poland	103
Emanuele Fassio, Asti, Italy	
EMHAES, Dennis Clarke, Venray, Netherlands	27
ENGEL Austria GmbH, Gerald Huber, Dietach, Austria	30
Engemovi Engenharia de Automação e Projetos Mecânicos Ltda, Walter Kapp, Curitiba, Brazil	72
Equipment Express, Paul Weiler, Ayr, Canada	
Eternal Vigor Technology, Chu Joseph, New Taipei City, Taiwan	142
Fanuc Robotics France, Mikael Laffay, Evry, France	33
FCC Construcción, Jorge Juan Abad Mateo, Madrid, Spain	74
Fehr Technologies RR, Cédric Jacky, Bischwiller, France	57
FERI (University of Maribor), Filip Cerne, Celje, Slovenia	56

Teilnehmer

Fiat Auto Poland, Andrzej Bednorz, Tychy, Poland	138
Flevo Engineers BV, Tonny Lagendijk, Emmeloord, Netherlands	29
Fonderie du Poitou Fonte, John Fouache, Ingrandes sur Vienne, France	66
Formopex Sp. z o.o., Przemysław Stasiuk, Strzelce Opolskie, Poland	75
Fresh Air Co., Ltd., Kou Sasaki, Tokyo, Japan	
Fresh Air K.K., Sasaki Kabuto, Tokyo, Japan	
FronTone GmbH, Carina Münzer, Feldkirchen, Austria	14
Gaia Indústria e Comércio Ltda., Paulo Renato Ávila, Porto Alegre, Brazil	117
Gala Systems Inc., Vincent Mathot, St-Hubert, Canada	70
Galli Industry, Dario Galli, Settimo Torinese, Italy	105
Geng-Shuen Co. Ltd., Jason Shen, Taichung City, Taiwan	144
Gepro Systems SL, Patxi Etxebarria, Durango, Spain	133
Global Machine Innovations, Robert Freese, Bridgend, UK	135
GMV AD, Luis Mollinedo Herrera, Tres Cantos, Spain	113
Goldhofer AG, Herbert Swoboda, Memmingen, Germany	90
Guangdong KEDA INDUSTRIAL Co., Ltd., Rongguang Zhou, Guangzhou, China	82
Güdel AG Schweiz, Thomas Mönch, Langenthal, Switzerland	80
GuoDian United Power Technology Company Ltd., Yi Zhang, Beijing, China	
Hagel Automation GmbH, Martin Hagel, Grünkraut-Gullen, Germany	93
Handsaeme Machinery, Matthias Vermeulen, Izegem, Belgium	130
Hardinge Taiwan Precision Machinery Ltd., Kin Chen, Nantou County, Taiwan	145
Hawa AG Werner Kollbrunner, Mettmenstetten, Switzerland	42
Heason Technology, Thomas Wells, Slinford, UK	109
Heinrich Martini, Brachtendorf, Germany	
Heinzel Fördertechnik und Stahlbau GmbH, Christian Ott, Thurnau, Germany	89

Participants



HOMAG Holzbearbeitungssysteme GmbH, Stefan Friese, Schopfloch, Germany	65
Huras Konstrukcja i Budowa Maszyn Specjalnych Sp. z o.o., Marek Zarzycki, Legnica, Poland	
IFREMER, Paul Jégou, Plouzane, France	62
IMV metalomecânica, Luis Amaral, Leiria, Portugal	106
ING Bank Slaski S.A., Judyta Banasiak-Słomiany, Katowice, Poland	78
Intra Industrial Technologies, Ravikumar Sampathirao, Hyderabad, India	
ipê móveis ind com., Hugo Batista Medeiros, Natal, Brazil	
Jeanologia SL, Albert Sans, Sant Quirze del Vallès, Spain	83
Jindal Saw Limited A59/60 Midc Sinner Nashik, Manoj Mishra, Nashik Road, India	129
Jindal Steel & Power Ltd, Umesh Chandra Mishra, Raigarh, India	
Johnson Controls Polska sp. z o.o., Radosław Chitrun, Swiebodzin, Poland	60
Ken Ichi Machine Co. Ltd., Brandon Wu, Taichung, Taiwan	132
Koike Korea, Junghoon Kim, Gimcheon-si, Gyung-sangbuk-do, Korea	139
Konstruktionsbüro Meier, Mario Meier, Mömbris, Germany	124
Les Machines de l'île, Bertrand Dekeuwer, Nantes, France	115
Lüber GmbH, Martin Ranger, Bazenheid, Switzerland	112
M, Takamasa Goto, Aichi-pref. Inazawa-city, Japan	
M/S Indo Rama Synthetics (India) Ltd., Nikhil Thakre, Nagpur, India	
Manford Machinery Industrial Co. Ltd., Stanley Huang, Nantou County, Taiwan	137
Marcotte Mining Machinery Services Incorporated, Ian Martin, Sudbury, Canada	21
Maschinenfabrik Heinrich Georg, Martin Göbel, Kreuztal, Germany	94
Max-Planck-Institut für biologische Kybernetik, Michael Kerger, Tübingen, Germany	58
MCRS Technology s.c., Jacek Stasiewicz, Starolecka, Poland	131
Mechan Ltd., Martin Berry, Sheffield, UK	81

Teilnehmer

MISS Group, Mohana Varma, Hyderabad, India	
MNA, Liang Hu, Nanjing, China	63
Monstal S.C, Marek Brela, Wałbrzych, Poland	127
Morow Ltd, Jonathan Butters, Liverpool, UK	116
MWV, Fabrice Avril, Deols, France	110
Neo Sieges France, Jérôme Causin, Neufchateau, France	39
OK Sp. z o.o., Filip Kempa, Konstancin-Jezierna, Poland	118
Ortmeier Maschinenbau, Stefan Zimmer, Langenhaslach, Germany	125
Otto Bihler Maschinenfabrik GmbH und Co. KG, Paul Maldoner, Halblech, Germany	16
P. H. U. KAM_EL, Kamil Maciniak, Lubartow, Poland	108
P.P.P Technical Sp.z o.o., Lukasz Nowakowski, Nowa Sól, Poland	
Pacific States Cast Iron Pipe Company, Brent Noel, Provo, USA	126
Pellereau Retraite / ing, Henri Pellereau, Langlade, France	
PHU DAR-MAT, Dariusz Zielinski, Gniezno, Poland	54
PHU Zakład Kamieniarski, Krzysztof Kwasek, Redziny, Poland	53
pi4_robotics GmbH, Tilo Förster, Berlin, Germany	77
Plasma Solutions Kjellberg, Jan van Overbeeke, Eke, Belgium	104
PLEVA GmbH, Fabian Buckenmayer, Empfingen, Germany	32
Politechnika Warszawska, Marcin Nikoniuk, Warszawa, Poland	95
Politechnika Wroclawska, Wydział Mechaniczny, Zakład Inżynierii Maszyn Roboczych i Pojazdów Przemysłowych, Piotr Dudzinski, Wrocław, Poland	68
POLON-IZOT Sp. z o.o., Piotr Zach, Milanówek, Poland	22
PPH Toka Sp z o.o, Zdzislaw Tomyslak, Przemierowo, Poland	45
Precision Automation and Robotics India Limited, Anil Deshinge, Pune, India	
Procma srl, Corrado Caruso, Modugno, Italy	35

Participants



PROFECTRONICS, Christian Geistberger, Piberbach, Austria	25
Przedsiębiorstwo Innowacyjno-Wdrozeniowe Wamet Sp. z o.o., Wieslaw Czajor, Bydgoszcz, Poland	46
Pt. Astra Otoparts Winteq Division, Deby Primadani, Bogor, Indonesia	131
Qualimark Machines Pvt. Ltd., Nimesh Pithava, Ahmedabad, India	
Quaser Machine Tools Inc., Kai Yang, Taichung City, Taiwan	122
Quickmill Inc, Chris Baklinski, Peterborough, Canada	86
Rhino Engineering Ltd, Ceri Couser, Port Talbot, UK	102
RINN Beton und Naturstein, Johannes Schramm, Heuchelheim, Germany	
Roto Frank sp z o.o., Bartłomiej Dudzik, Lubartów, Poland	84
RWD Life Science Co., Ltd, Yuying Chen, Shenzhen, China	
Salmoiraghi S.p.A., Gianluca Della Rosa, Monza, Italy	
Salzgitter Flachstahl GmbH, Jan-Marten Claus, Salzgitter, Germany	85
SBS Bühnentechnik GmbH, Steffen Nürnberger, Dresden, Germany	47
Schaal Oberflächensysteme, Herbert Haga, Sigmaringendorf, Germany	120
Scheffer Krantechnik GmbH, Michael Petermann, Sassenberg, Germany	119
Schleuter Maschinen- und Apparatebau, Thomas Pruszek, Oyten, Germany	91
Selini Group, Luigi Alari, Lombardia, Italy	43
serva transport systems GmbH, Leopold Meirer, Grabenstätt, Germany	48
Shuz Tung Machinery Industrial Co., Ltd., Su-How Yang, Taichung City, Taiwan	132
Sitec Industrietechnologie GmbH, Jens Köhler, Chemnitz, Germany	97
SLEEVEVER, Dominique Cossais, Morangis, France	69
Smyth, Matteo Cerruti, Moncalvo, Italy	127
Soenen, Steve Hoozée, Roeselare, Belgium	101
Sogeclair Aerospace S.A., Sebastien Pintos, Getafe, Spain	136

Teilnehmer

Sotralentz, Denis Roth, Drulingen, France	23
Starfrost Uk Ltd., Robert Long, Lowestoft, UK	107
STEEL FLOWER, Jakyung Ku, Pohang-si, Kyungsangbuk-do, Korea	140
SUMITOMO, Kevin Lee, Tainan City, Taiwan	
SuZhou Hawk-Foundry Equipment Co., Ltd., Xiangui Lu, Suzhou, China	
SYMETRIE, Olivier Lapierre, Nimes, France	20
Tarkett doo, Trivun Radoš, Backa Palanka, Serbia	
Tata Steel Ltd. Hooghly Met Coke Division, Sujit Dutta, Haldia Westbengal, India	41
TECH EYE Corp., Hyeong Jun Lee, Bucheon-si, Gyonggi-do, Korea	
Tekra Sp. Z o.o., Medard Kaczmarek, Gubin, Poland	24
Testchem Sp.z o. o., Roman Suchanek, Pszów, Poland	59
The Indo Tech Plant Services, Chandan Makar, Howrah, Westbengal, India	
Thönniges Engineering, Albert Thönniges, Köln, Germany	34
TKM projekt, Michal Rodak, Wrocław, Poland	44
Tocardo Tidal Turbines, Martijn Teela, Den Oever, Netherlands	76
TTM Tomasz Tobiasz, Tomasz Tobiasz, Bratucice, Poland	137
Umbelino Monteiro SA, Rui Jorge Lopes Marques, Pombal, Portugal	128
Universal Factory Automation, Bangalore, Srinivasa Prasanna Kumar, Bangalore, India	
Universität Duisburg-Essen, Christian Sturm, Duisburg, Germany	12
Van Hoecke Automation nv, Steven Van Cauwenberghe, Gavere, Belgium	140
VdW International, Stéphane De Coussemaker, Ganshoren, Belgium	133
VECTRON Technology Co., Ltd, Xuefeng Liu, Shenzen, China	
Villa Sistemi Medicali, Gabriele Longoni, Buccinasco, Italy	71
Vinyl I, Intak Joo, Seoul, Korea	141
Vitronics Soltec B.V., Christ Aertse, Oosterhout, Netherlands	38

Participants



VM, José Eduardo Morais, Curitiba, Brazil	
Wicreations, Koen Peeters, Heist-op-den-Berg, Belgium	18
Wistron NeWeb Corp., Huang Shih Fong, Hsinchu Science Park, Taiwan	31
Yamazaki Mazak Corp., Hisako Kojima, Minokamo, Japan	
Yixing Xinyu Technology Co., Ltd., Shusheng Zhang, Yixing, China	142
Z.P.U.H. Mikron S.C. Marcin Sobun, Waclaw Kurowski, Krzysztof Sobun, Wiamowice, Poland	130
Zakład Produkcji Form, Narzedzi Specjalnych i Przetwórstwa Tworzyw Sztucznych „GRAFORM“, Grzegorz Pichłacz, Bydgoszcz, Poland	52
Zakład Techniki Próżniowej TEPRO SA, Damian Capała, Koszalin, Poland	64
Zemat Technology Group Ltd., Sebastian Zródely, Łódź, Poland	50
ZPA-RP a.s., Martin Susansky, Sokolov, Czech Republic	49



www.vector-award.de

vector@igus.de

vector® koordinationsbüro
c/o igus® gmbh
postfach 90 61 23
51127 köln

www.vector-award.com

vector@igus.de

vector® coordination office
c/o igus® gmbh
po Box 90 61 23
d-51127 cologne

Die Begriffe igus, e-ketten, e-kettensysteme, chainflex, readycable, easychain, e-chain, e-chainsystems, energy chain, energy chain system, flizz, readychain, triflex, twisterchain, invis, drylin, iglidur, igubal, xiros, xirodur, plastics for longer life, manus, vector sind für die igus® GmbH/Köln in der Bundesrepublik Deutschland und gegebenenfalls international markenrechtlich geschützt.

The terms igus, e-ketten, e-kettensysteme, chainflex, readycable, easychain, e-chain, e-chainsystems, energy chain, energy chain system, flizz, readychain, triflex, twisterchain, invis, drylin, iglidur, igubal, xiros, xirodur, plastics for longer life, manus, vector are legally protected trademarks for igus® GmbH/Cologne in the Federal Republic of Germany and, where applicable, in some foreign countries.

weitere spektakuläre Anwendungen mit igus® e-ketten®
www.igus.de/anwendungen

more exciting applications with igus® e-chains®
www.igus.eu/applications